



METER

EM60



TABLE OF CONTENTS

1. Introduction	1
2. Operation	2
2.1 Installation	2
2.2 Configuration	4
2.3 Cellular Communication Test (EM60G Only)	9
2.4 Instantaneous Sensor Measurements Scan	10
2.5 Data Download	10
2.6 Data Deletion	11
3. System	12
3.1 Specifications	12
3.2 EM60 Hardware Components	13
3.2.1 Sensor Interface	14
3.2.2 Sensor Measurement Interval	15
3.2.3 Test Button	15
3.2.4 Status Lights	16
3.2.5 Batteries	16
3.2.6 GPS Receiver	17
3.2.7 Timekeeping	17
3.2.8 Data Storage	18
3.2.9 Cellular Communications (EM60G Only)	18
4. ZENTRA Software	19
4.1 ZENTRA Utility	19
4.1.1 Button Toolbar	20
4.1.2 Data Logger Identification Area	20

4.1.3 Active Sensors and Measurements Area.....	21
4.1.4 Status Bar.....	21
4.1.5 Menu Bar.....	21
4.1.6 Manage Settings Dialog.....	27
4.2 ZENTRA Cloud (EM60G Only).....	31
5. Service.....	33
5.1 Maintenance.....	33
5.2 Troubleshooting.....	34
5.3 Customer Support.....	36
5.4 Terms and Conditions.....	36
Appendix A. Compliance Certifications.....	37
A.1 USA.....	37
A.2 Canada.....	38
A.3 European Union.....	38
A.4 Japan.....	39
Index.....	40

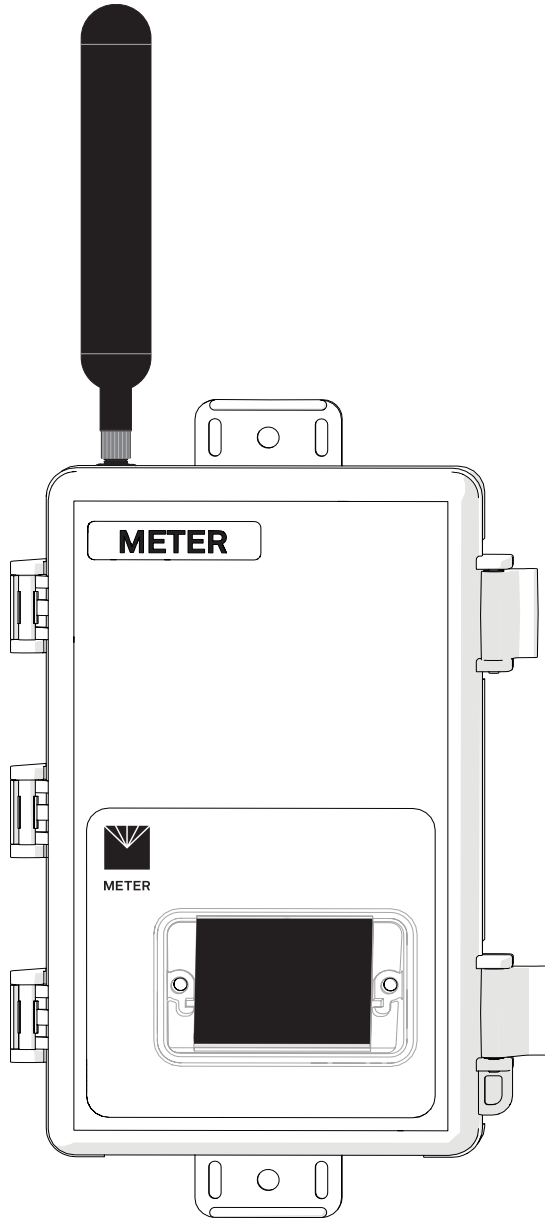

1. INTRODUCTION

Thank you for choosing EM60 series data loggers from METER Group.

The EM60 series loggers (EM60 and EM60G) are part of the ZENTRA System, a collection of data loggers, software, and compatible sensors to measure soil moisture and other environmental parameters accurately and cost effectively. Please refer to EM60 specifications at metergroup.com/em60-support for an up-to-date list of supported sensors.

The EM60 is a self-contained, plug-and-play data logger for field research and commercial agriculture. It is housed in a weather-resistant enclosure, making it suitable for long-term outdoor operation. The logger also includes built-in circuitry to charge nickel-metal hydride (NiMH) batteries using energy from an integrated solar panel.

The EM60 series includes two models:

- EM60 is a manual-download logger.
- EM60G is a remote-download logger that communicates through a cellular module to transmit data over the internet.

Throughout this manual, references to EM60 apply to both the EM60 and EM60G versions of the logger unless otherwise specified.

Verify all instrument components are included and appear in good condition:

- EM60 series logger with five installed rechargeable NiMH batteries
- Micro-USB communications cable
- Zip ties for mounting the logger
- USB drive containing ZENTRA Utility software installer
- Antenna (EM60G)
- Device subscription card (EM60G)

2. OPERATION

This section explains the basic workflow of logger installation, logger configuration, and data download. Please read all instructions before operating the EM60 to ensure it performs to its full potential. Consider testing the EM60 and sensors in a lab or office prior to field installation to verify the correct operation of the system.

The EM60 can serve as a data collection station for as many as six sensors. It is designed to be a plug-and-play setup with all METER sensors, including the ECH₂O water content sensors, ATMOS weather sensors, and TEROS soil moisture sensors. Please refer to the individual sensor manuals for sensor installation instructions.

2.1 INSTALLATION

Follow the steps listed in [Table 1](#) to set up the EM60 and start collecting data.

Table 1 Installation

Tools Needed	<p>Microsoft® Windows® or Apple® Mac® computer</p> <p>Mounting post (or similar)</p>
	<p>Install ZENTRA Utility</p> <p>Use the included USB drive to install ZENTRA Utility:</p> <ul style="list-style-type: none"> • On a Windows computer, open the My Computer window, select the USB drive, and double click on ZENTRA Utility PC Installer.exe. • On a MacOS computer, using Finder®, select the USB drive, and double click on ZENTRA Utility Mac Installer.pkg. <p>Alternatively, use the ZENTRA Utility Installer link on the EM60 webpage (metergroup.com/em60-support).</p> <p>The installer automatically installs the necessary USB driver for the EM60.</p> <p>Remove Battery Pull-Tab</p> <p>Inside the EM60, remove the battery pull-tab from the batteries.</p> <p>NOTE: Alkaline batteries can be used in EM60 loggers but will not be recharged by the solar battery charger.</p> <p>The status lights will eventually settle to a short, single blink every 5 s, signaling it is ready for use.</p> <p>Attach Antenna (EM60G Only)</p> <p>Remove the red connector cap from the antenna connector on top of the EM60G.</p> <p>Twist the antenna directly onto the antenna connector.</p>
Preparation	

Table 1 Installation (continued)

Configuration	<p>Configure the EM60 Using ZENTRA Utility NOTE: This step can also be done in the field. Connect the micro-USB cable to a computer and logger.</p> <p>Open ZENTRA Utility and select Connect (Section 2.2).</p> <p>Set the measurement interval and verify the EM60 is correctly configured for the sensors that will be installed. NOTE: By default, the EM60 is configured to store sensors readings every 15 min. Consider reinstalling the battery pull-tab until deploying the logger in the field.</p>
	<p>Select Location</p> <p>Choose a location and orientation to give the solar panel the maximum amount of sunlight. In the northern hemisphere, this will typically mean the data logger will face south; in the southern hemisphere, this will typically mean the data logger will face north.</p> <p>Additional location considerations may include vegetation cover throughout the season, distance from power lines, minimal livestock, etc. NOTE: If the location is in an area where solar energy harvesting is minimal, alkaline batteries will power the logger longer than the NiMH batteries when not being recharged by the solar panel. The EM60 does not charge alkaline batteries.</p> <p>For EM60G loggers, evaluate how surroundings may attenuate the cellular signal. Do not install EM60G loggers near large metallic objects.</p>
Field Installation	<p>Remove Battery Pull-Tab (if still installed)</p> <p>Check Cellular Communication Quality (EM60G) Use ZENTRA Utility to check the quality of the cellular signal (Section 2.3).</p> <p>If the signal is low or cellular test fails, move to an alternative location (sometimes moving only a few meters is sufficient).</p> <p>Fasten Logger to Mounting Post Use the loopholes on the top and bottom of the logger enclosure to mount the EM60 to a post using the zip ties or a similar fastener.</p> <p>Ensure the logger is installed in an upright position to reduce the possibility of water entering the EM60 enclosure. NOTE: The EM60 case is water resistant, not waterproof. In extremely wet environments or environments with prolonged high humidity, enclose a desiccant packet inside the logger or enclose the logger in a waterproof case.</p>

Table 1 Installation (continued)

Field Installation (continued)	Fasten Logger to Mounting Post
	Use the loopholes on the top and bottom of the logger enclosure to mount the EM60 to a post using the zip ties or a similar fastener.
	Ensure the logger is installed in an upright position to reduce the possibility of water entering the EM60 enclosure.
	NOTE: The EM60 case is water resistant, not waterproof. In extremely wet environments or environments with prolonged high humidity, enclose a desiccant packet inside the logger or enclose the logger in a waterproof case.
	Install Sensors
	Install each sensor as directed in the sensor user manual.
	Thread cables in conduit or plastic cladding when near the ground to avoid rodent damage.
	Plug the sensor plug connectors firmly into the EM60 input ports.
	Secure sensor cables to mounting post with some cable slack between the EM60 and the post.
	Perform instantaneous scan to ensure sensors are working properly (Section 2.4).

2.2 CONFIGURATION

The measurement interval and sensor types must be set before data will be stored by the logger.

ZENTRA Utility ([Section 4.1](#)) is used to configure the operational parameters of both EM60 and EM60G. ZENTRA Cloud can also be used to remotely update most of the EM60G settings ([Section 4.2](#)). This manual will focus on the ZENTRA Utility software as the primary interface to the EM60.

To configure EM60 in ZENTRA Utility, refer to the following steps:

1. Open the ZENTRA Utility application ([Figure 1](#)).

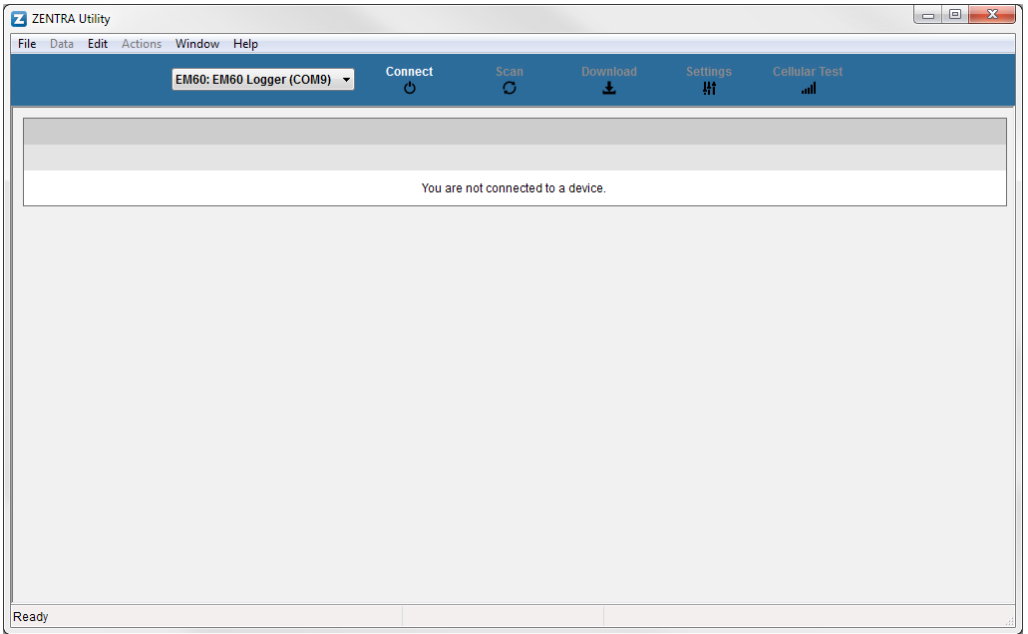

Figure 1 ZENTRA Utility initial screen

2. Plug the micro-USB cable into the logger USB port and the computer USB port.
3. On the ZENTRA Utility main screen, select the appropriate COM port from the dropdown menu (Figure 2).

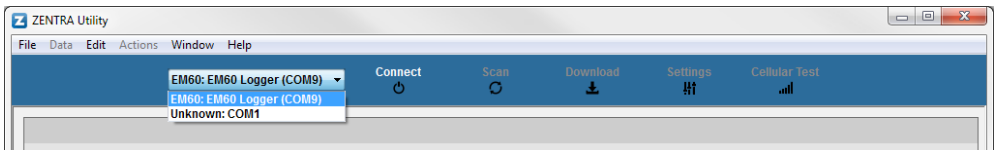

Figure 2 COM port dropdown

4. Click the Connect button next to the COM port dropdown menu (Figure 2).
Once successfully connected, ZENTRA Utility displays the instantaneous sensor measurements from the EM60 (Figure 3).

OPERATION

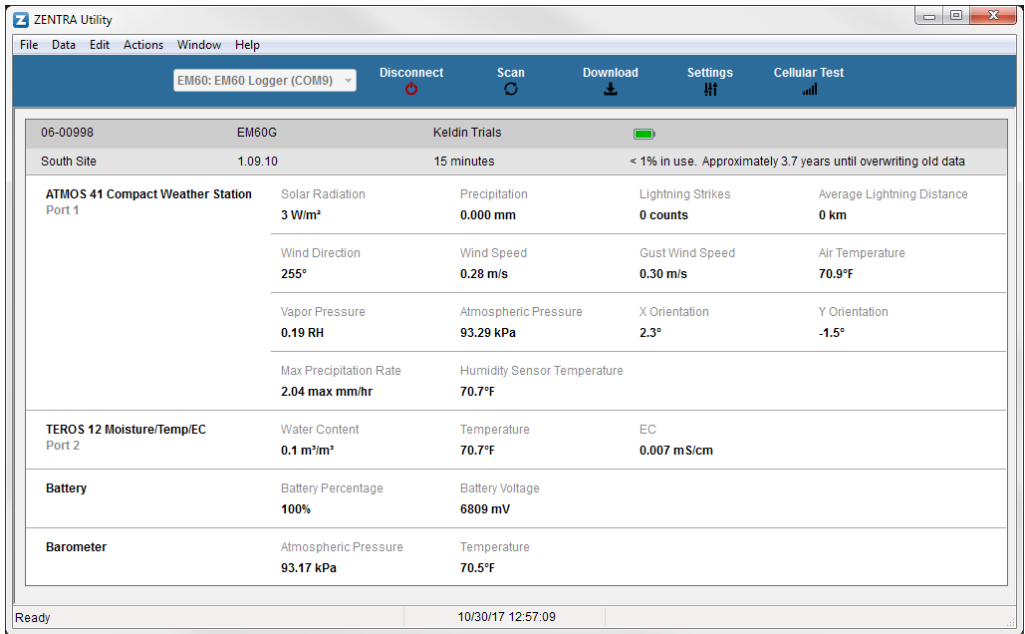

Figure 3 EM60 connected and showing instantaneous measurements

5. Click the Settings button in the Button toolbar.
The Manage Settings dialog will appear.
6. Navigate to the Device Information tab (Figure 4).

EM60

The screenshot shows the 'Manage Settings' window with the 'Device Information' tab selected. The window contains several input fields with the following values: Device Name: South field; Site Name: Keldin Trials; Serial Number: 06-00998; Time Zone: UTC-7; Firmware Version: 1.09.10; Device Type: EM60G. At the bottom, there are 'OK' and 'Cancel' buttons. The status bar at the very bottom indicates 'Ready'.

Figure 4 Device Information tab

7. Enter a device name.

This field is prepopulated with the device serial number. Consider changing the name to the field or plot where the EM60 is installed.

8. Navigate to the Sensor Configuration tab (Figure 5).

The screenshot shows the 'Manage Settings' window with the 'Sensor Configuration' tab selected. The window contains the following settings: Measurement Interval: 15 minutes; Data Storage: 0.1% in use. - Approximately 3.7 years until overwriting old data; Sensor Type: ATMOS 41 Compact Weather Station; Firmware Version: 0. At the top, there are tabs for Port 1 through Port 6. At the bottom, there are 'OK' and 'Cancel' buttons. The status bar at the very bottom indicates 'Ready'.

Figure 5 Sensor Configuration tab

OPERATION

- Adjust the Measurement Interval to the desired time between storing sensor measurements.
[Section 3.2.2](#) provides more information on how the EM60 makes sensor measurements.

10. Plug sensors into the EM60 sensor ports.

- Ensure the correct sensor type is listed in each port tab ([Figure 6](#)).

If the sensor is not automatically recognized, pick the correct sensor setting from the Sensor Type dropdown menu.

NOTE: For EM60G, check the cellular signal ([Section 2.3](#)) at the expected installation location before installing sensors.

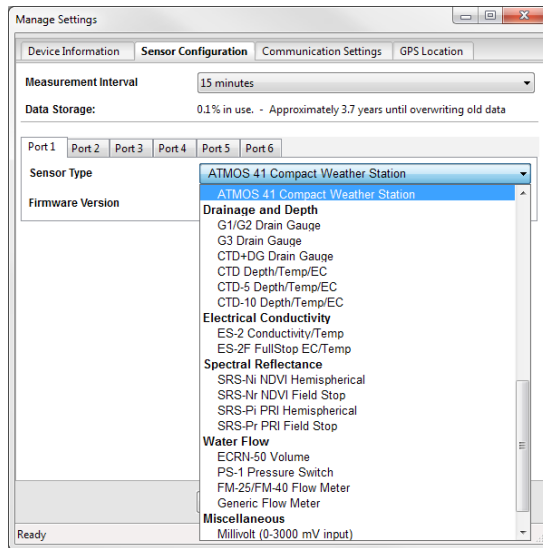

Figure 6 Select Sensor Type dropdown

- If configuring an EM60 logger, click OK. This completes the configuration.
If configuring an EM60G logger, continue to [step 13](#).
- Navigate to the Communication Settings tab ([Figure 7](#)).

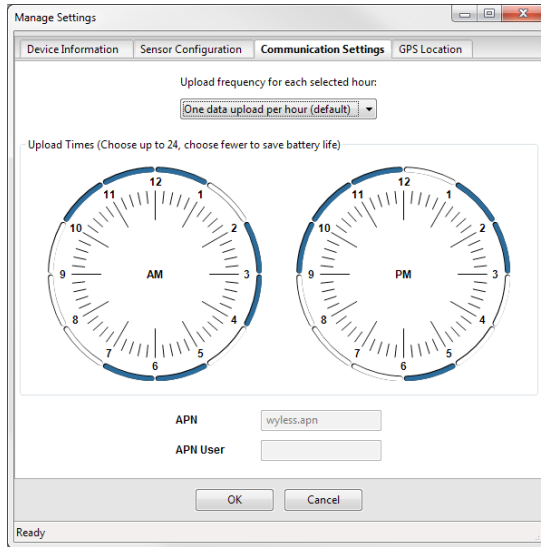

Figure 7 Communication Settings tab (EM60G only)

14. Select the time segments in Upload Times by clicking the arc segments for the hour intervals.

EM60G will upload data during the selected intervals ([Section 4.1.6](#)).

15. Click OK.

2.3 CELLULAR COMMUNICATION TEST (EM60G ONLY)

A successful communication test will confirm that the EM60G can transmit data to servers as well as the strength of that connection. Even a poor connection indicates that data are being successfully transferred. Prior to installing the sensors and EM60G, check the cellular connection at the location:

1. Click the Cellular Test button in the Button toolbar.

The Cellular Communication Test dialog will appear ([Figure 8](#)).

OPERATION

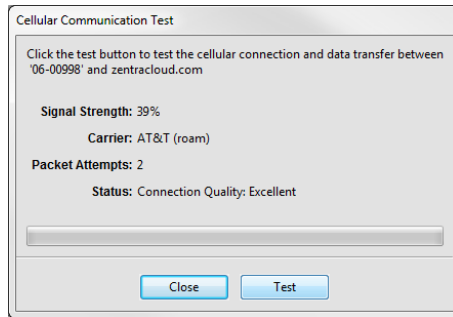

Figure 8 Cellular Communication Test dialog

2. Click Test.
3. If the logger fails the test, move to a new location and try again.
Sometimes, even moving just a few meters will provide a successful connection.

NOTE: For increased signal strength, the antenna should be unobstructed by structures or vegetation. Consider the expected growth of plant canopy around the antenna. An antenna extension cable can also be used to elevate the antenna for increased signal strength.

4. Click Close.

2.4 INSTANTANEOUS SENSOR MEASUREMENTS SCAN

ZENTRA Utility will automatically scan the sensors attached to the EM60 every 30 s and update the readings shown on the main screen ([Section 4.1.3](#)).

ZENTRA Utility can also take real-time sensor measurements with the EM60 on demand. This is a critical tool to ensure sensors are installed correctly, to test if a sensor is reading properly, or to evaluate how sensors react to environmental changes. The EM60 does not store data that it measures with the scan function.

To force a new scan to occur at any time, press the Scan button in the Button toolbar ([Section 4.1.1](#)). The sensor and measurement area will refresh.

2.5 DATA DOWNLOAD

While at the installation site, allow the EM60 to collect data for one or two measurement intervals, and download the collected sensor data to ensure the monitoring setup is working correctly. Periodically return to the site to download the stored data to check the logger operation and to retrieve stored data.

Download saved sensor and status data with ZENTRA Utility using the following steps:

1. Connect the logger to a computer using the micro-USB cable.
2. Open ZENTRA Utility.

3. Choose the appropriate COM port from the dropdown list.
4. Click Connect.
5. Click Download on the Button toolbar. This will download the data stored since the last successful download.

Alternatively, go to the Data menu in the Menu bar and select either Download New (downloads the data stored since previous download) or Download All (downloads all the data currently stored in the EM60).

6. Edit the File Name in the Save dialog. A suggestion will appear, based on the connected logger name and the time and date.
7. Select the location on the computer where the file will be saved.
8. Click Save.

ZENTRA Utility downloads sensor data and creates a Microsoft® Excel® compatible file. The time-series sensor data saves to the Processed Records sheet of the workbook with metadata saved to the Metadata sheet. Metadata includes logger configuration settings, logger location, and sensor metadata, such as serial number and firmware version.

ZENTRA Utility will download data in the units chosen under Measurements in Manage Preferences dialog ([Section 4.1.5](#)).

The EM60G was designed to send measurement data to zentracloud.com using the cellular network. After these data are uploaded, they are available for viewing and downloading in the ZENTRA Cloud application ([Section 4.2](#)).

2.6 DATA DELETION

It is not necessary to delete data on the EM60 once all of the memory has been used. The EM60 will start overwriting the data starting with the oldest records.

Erasing data stored on the EM60 is done with ZENTRA Utility. Before erasing data, download and save data onto a computer. To erase data, follow the steps below:

1. In ZENTRA Utility, click on the Data menu on the Menu bar.
2. Select Erase. A dialog will appear.
3. Click Erase Data to remove data.
Click Cancel to return to ZENTRA Utility without removing data.

CAUTION: This feature permanently erases all stored data on the EM60. Data previously transmitted to ZENTRA Cloud are not erased.

3. SYSTEM

This section reviews the EM60 data logger hardware features and configuration options. Use this information to help optimize each environmental monitoring setup.

3.1 SPECIFICATIONS

Sensor Input Ports	6 (supports METER analog, digital, or pulse sensors)
Sensor Port Type	3.5-mm stereo plug connector
Logging Interval	1 min to 12 h (EM60) 5 min to 12 h (EM60G)
Reporting Interval (EM60G)	Hourly with additional charges for more frequent reporting
Data Storage	8 MB (40,000 to 80,000+ records depending on configuration)
Memory Type	Nonvolatile flash, full data retention with loss of power
Global Position	Integrated 56-channel GPS/QZSS receiver
GPS Position Update	Daily (automatic) and on-demand (manual)
GPS Position Accuracy	±3 m, with good sky view
Timekeeping	Synchronize automatically and on-demand; GPS system, cellular (EM60G), or software
Battery Capacity	Five AA NiMH or alkaline batteries
NiMH Battery Charging	Solar energy harvesting or USB
NiMH Battery Life	3+ years with unobstructed view of sun
Alkaline Battery Life	18 to 24 months (EM60) 3 to 12 months depending on configuration (EM60G)
Computer Communication	Standard USB cable, USB A to micro-B
Cellular (EM60G)	UMTS 3G 5-band Cellular Module with 2G fallback
Cellular Coverage	AT&T and T-Mobile in USA, 200+ global partner carriers. Cellular and data hosting service provided by METER.
Internet Downloads	SSL/TLS encrypted
Enclosure	Weather-, impact-, and UV-resistant polymer
Enclosure Size	12.7 cm × 20.3 cm × 5.1 cm (5 in × 8 in × 2 in)

Enclosure Access	Hinged door with latches and eyelet for lock or zip tie
Operating Environment	-40 to +60 °C (0% to 100% relative humidity)

Compliance

Manufactured under ISO 9001:2015

EM ISO/IEC 17050:2010 (CE Mark)

3.2 EM60 HARDWARE COMPONENTS

The EM60 logger series (Figure 9) includes two models:

- EM60 is a basic logger that communicates through a micro-USB cable to a computer.
- EM60G is a logger that, in addition to USB communication, also communicates through a Universal Mobile Telephone Service (UMTS) cellular module. This allows remote configuration and environmental measurement data transmission over a cellular network.

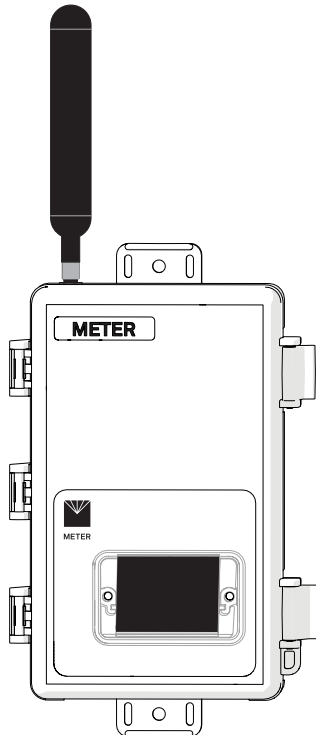

Figure 9 EM60G data logger exterior. EM60 is identical, without an antenna.

SYSTEM

The logger is housed in a weather-resistant enclosure. In extremely wet environments or environments with prolonged high humidity, enclose a desiccant packet inside the logger or enclose the logger in a waterproof case.

EM60 is purpose-built to collect data from environmental sensors sold by METER. The data logger has six ports for sensors and a micro-USB port for communicating with a computer (Figure 10). The data logger interior also contains a TEST button (Section 3.2.3) and two status lights, OK and ERROR (Section 3.2.4). The logger uses five batteries, and solar cells will recharge NiMH batteries (Section 3.2.5).

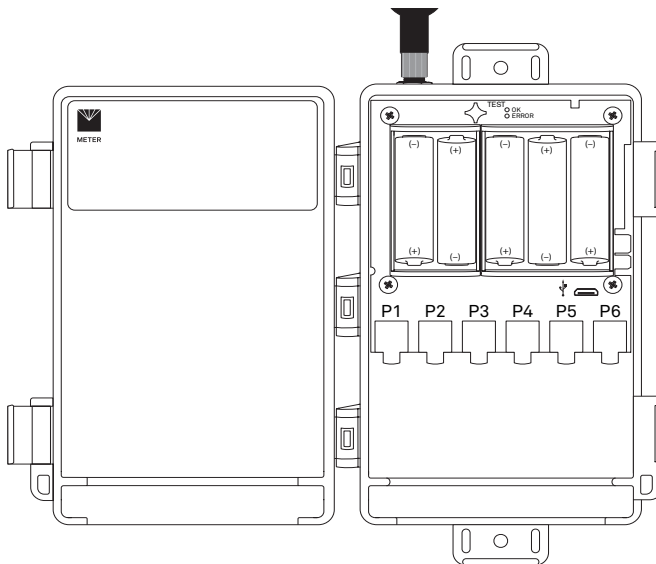

Figure 10 EM60G data logger interior. EM60 is identical.

3.2.1 SENSOR INTERFACE

EM60 will detect the presence of most types of sensors when connected to the sensor ports. The EM60 will detect METER digital sensors and autopopulate the Sensor Type dropdown on the Manage Settings dialog in ZENTRA Utility (Section 4.1.6). For METER analog sensors, the EM60 will show Unrecognized Sensor in the Sensor Type dropdown. Some sensors (such as pulse sensors) will not be detected by the EM60. In these latter two cases, the sensor will have to be manually selected from the dropdown menu.

NOTE: It is critical that the EM60 is configured correctly for the attached sensors. Without correct configuration, the EM60 will not record useful sensor information.

The EM60 is able to detect when many of the METER sensors are unplugged or malfunctioning. The logger stores error codes in the place of normal sensor measurements in this event. ZENTRA software will display these errors to help troubleshoot problems with

the sensors. The EM60 cannot determine the difference between an intentionally uninstalled sensor and a malfunctioning sensor. Update the sensor configuration if sensors are removed from or added to the EM60.

3.2.2 SENSOR MEASUREMENT INTERVAL

The measurement interval controls how often the EM60 records sensor data to internal nonvolatile data storage. The interval applies to all ports on the EM60 (i.e., EM60 cannot store data for one sensor at a faster rate than another sensor). This setting is controlled in the Sensor Configuration tab of the Manage Settings dialog ([Section 4.1.6](#)).

The measurement interval works relative to the EM60 internal real-time, 24-h clock. For example, a measurement interval of 2 h results in the EM60 storing data every 2 h, on the hour (e.g., 12:00 am, 2:00 am, ..., 10:00 pm). The EM60 and EM60G support 1 min and 5 min, respectively, as the minimum value for the measurement interval setting. The maximum measurement interval for both models is 12 h. For most applications, a measurement interval of 15 min is appropriate.

The EM60 makes a measurement from each of the six sensor ports in use every 60 s. When the EM60 internal clock reaches the user-configured measurement interval, the EM60 processes and stores the results from all the 60-s sensor readings taken since the last storage interval. For most sensors, the stored results are a simple average of the per-minute readings. For example, if the measurement interval for a GS3 soil moisture sensor is 60 min, the EM60 stores an average of the past 60 sensor readings. Data are summed for pulse-based sensor like a rain gauge. Some METER sensor user manuals contain more details of how the EM60 processes sensor readings.

NOTE: Setting the EM60 measurement interval to Off (not logging) turns off sensor measurement, data storage, and EM60G data uploads.

3.2.3 TEST BUTTON

Pressing the TEST button initiates the self-test sequence. For EM60 loggers, the self-test takes about 6 s to complete. For EM60G loggers, the self-test can take 60 s or more because of testing communications over the cellular network. The following actions are part of the self-test sequence:

1. Reboot the EM60.
This ensures internal software restarts and is operating in the expected way. Both status lights stay lit during the reboot. This reboot will not erase data or reset settings.
2. Perform basic functionality testing on internal systems and evaluates the amount of charge in the battery.
Both the green and red lights blink together slowly while the logger performs tests.
3. Autodetect the connected sensors ([Section 3.2.1](#)).

4. Start the embedded GPS receiver to obtain a current time and location fix ([Section 3.2.6](#)). This process takes up to 15 min to complete.
5. Establish an internet connection over the cellular network and attempt to communicate with ZENTRA Cloud (EM60G only).

After completing the self-tests, the EM60 will indicate success or failure by lighting either the red or green status light.

- A solid green light (for approximately 20 s) indicates that internal tests passed and, if applicable, there is successful communication over the cellular network.
- A solid red light indicates an error in the logger, which may include:
 - ♦ Corrupt EM60 logger firmware
 - ♦ Low batteries
 - ♦ Unsuccessful EM60G communications

Use ZENTRA Utility to identify where the self-tests may have failed ([Section 4.1](#)) or consult troubleshooting to resolve logger errors ([Section 5.2](#)).

3.2.4 STATUS LIGHTS

Lights near the TEST button indicate the status of the EM60. A green light is labeled OK and a red light is labeled ERROR. There are several possible status states:

- The green light gives a short, single blink every 5 s to indicate the EM60 is configured to log sensor data.
- The green light blinks slowly (1 s on, then 1 s off), to indicate the logger is communicating to a computer or using the cellular module.
- The green and red lights blink together during self-test procedures (after pressing the TEST button or pulling the battery tab).

At the conclusion of the self-tests, either the green or the red light will remain lit to indicate the results of the test.

- The lights remain off if the logger measurement interval is set to Off (not logging).

3.2.5 BATTERIES

The EM60 is designed to use either AA NiMH rechargeable batteries or AA alkaline nonchargeable batteries. The logger autodetects the type of batteries installed and automatically adjusts the internal thresholds to represent 100% and 0% battery power.

NOTE: Do not mix NiMH and alkaline batteries together. Do not mix new and old alkaline batteries together.

Use NiMH batteries if the EM60 will be installed outdoors, where it can harvest solar energy to charge NiMH batteries. Orient the EM60 enclosure to expose the solar panel to the maximum amount of sunlight available. In the northern hemisphere, this typically means that the data logger will face south; in the southern hemisphere, this typically means that the data logger will face north. There may be local obstructions that make another

orientation more favorable. The logger will charge the batteries even during periods of low light levels (e.g., winter time or heavy overcast conditions). For extended periods of low light, the incoming energy may be lower than the energy needed to operate the logger. The batteries will buffer the energy needs of the logger for several months and will return to full capacity as the incoming energy exceeds the energy needed to operate the logger.

The EM60 will also harvest energy from the USB connection to a computer. Plugging the logger into a USB port for several hours will help restore NiMH batteries to full capacity.

Use alkaline batteries if the EM60 will be installed indoors or in a location where the harvested solar energy is not sufficient to keep the NiMH batteries charged. Alkaline batteries will last longer than NiMH batteries that are not being charged (6 to 7 months for an EM60G; more than 2 years for an EM60).

The EM60 is designed to prioritize sensor measurements over both the GPS and cellular communications features. If the battery level reaches a critical threshold (showing 0% in software), the logger will stop using the GPS receiver and the cellular radio (EM60G). The logger will continue to make sensor measurements until the battery charge is too low to provide excitation power to the sensors. When new batteries are installed or recharged, the GPS receiver and cellular radio functionality will automatically start working again.

Logged data is stored with nonvolatile flash memory and will not be lost if battery power fails. However, power must be restored to the logger to download data.

3.2.6 GPS RECEIVER

The EM60 logger has a built-in GPS receiver that provides the latitude, longitude, and altitude of the logger. It is designed to provide a time fix and location metadata for the environmental monitoring location. The EM60 does not record the location of each individual sensor reading and is not optimized for applications such as geotagging a moving sensor platform.

The EM60 enables the GPS receiver once per day. If the logger determines its location has not changed, it turns off the GPS receiver to save power. If the EM60 detects a change, it keeps the GPS receiver powered for as long as 15 min to improve the accuracy of the location fix. Pressing the TEST button on the EM60 triggers the logger to evaluate changes in location ([Section 3.2.3](#)).

3.2.7 TIMEKEEPING

The EM60 keeps track of time using Universal Time Coordinated (UTC) seconds. The EM60 synchronizes time using either a computer running ZENTRA Utility or the GPS receiver. The EM60G can also synchronize time with the cellular network and ZENTRA Cloud. The EM60 prioritizes using GPS time since this will be the most accurate; however, the logger will fall back to the other sources of time when the EM60 does not have a good GPS time fix.

Data collected by the EM60 uses the UTC time for timestamp on each saved sensor record. ZENTRA Utility and ZENTRA Cloud display these data using local time based on where the logger is installed. The EM60 time zone setting calculates local time for the logger and is set by the computer running ZENTRA Utility or by the cellular network (if the network supports this feature).

3.2.8 DATA STORAGE

The EM60 only stores data for sensor ports that are configured for sensors ([Section 3.2.1](#)).

The EM60 stores up to 8 MB of data. When the logger has filled its memory, it begins overwriting the oldest data in the memory. Data storage varies between approximately 6 months to over 300 years depending on the sensors used and the measurement interval. ZENTRA Utility software displays how many days of data the EM60 can hold based on the current measurement interval ([Section 3.2.2](#)), sensor configuration, and previously stored data .

The EM60 data memory is nonvolatile flash. Removing the batteries or rebooting the logger ([Section 3.2.3](#)) will not erase stored sensor measurement data.

The EM60 stores encoded data for each sensor to make data storage and transmitting convenient. ZENTRA software automatically decodes the sensor data to display them correctly.

3.2.9 CELLULAR COMMUNICATIONS (EM60G ONLY)

The EM60G has a built-in cellular module for uploading measurement data to ZENTRA Cloud. This allows for near real-time monitoring of the environment at the measurement site.

The EM60G powers the cellular module only long enough to upload the data collected since the last time the logger successfully reported. During these upload times, the EM60G transfers data to ZENTRA Cloud and retrieves any pending settings changes.

Upload session frequency and timing can be changed in ZENTRA Utility ([Section 4.1.6](#)) or ZENTRA Cloud. The default setting is for the EM60G to upload data once per hour at a random time within each hour of the day. Less frequent uploads conserve battery power.

NOTE: Contact [Customer Support](#) if more frequent uploads are needed.

The EM60G operates with AT&T® and T-Mobile® networks in the United States. The EM60G also works with over 200 roaming partners around the world.

4. ZENTRA SOFTWARE

The EM60 is designed to work with ZENTRA Utility and ZENTRA Cloud. Both ZENTRA Utility and ZENTRA Cloud software allow the user to collect and manage data from the device. ZENTRA Utility is on the included USB drive or can be downloaded from metergroup.com. ZENTRA Cloud is a web-based application to remotely download spreadsheets, view data, and configure the EM60G (Section 4.2).

NOTE: ZENTRA Utility does not communicate with an EM60G logger over the cellular network and internet. The logger must be physically plugged into the computer to download data via ZENTRA Utility. Use ZENTRA Cloud to download EM60G data when not directly connected to the logger.

4.1 ZENTRA UTILITY

ZENTRA Utility is a user-friendly interface for configuring and downloading data from the EM60 logger that can be used on any MacOS (10.9 and above) or Microsoft Windows (7 and above) laptop, netbook, or desktop computer. With ZENTRA Utility, the user can

- connect to EM60 loggers directly,
- set all logger configuration parameters,
- make real-time sensor measurements (scan sensors), and
- create Excel files with sensor data.

The ZENTRA Utility main screen should appear upon launch (Figure 11). Use the Menu bar and Button toolbar to interact with the EM60.

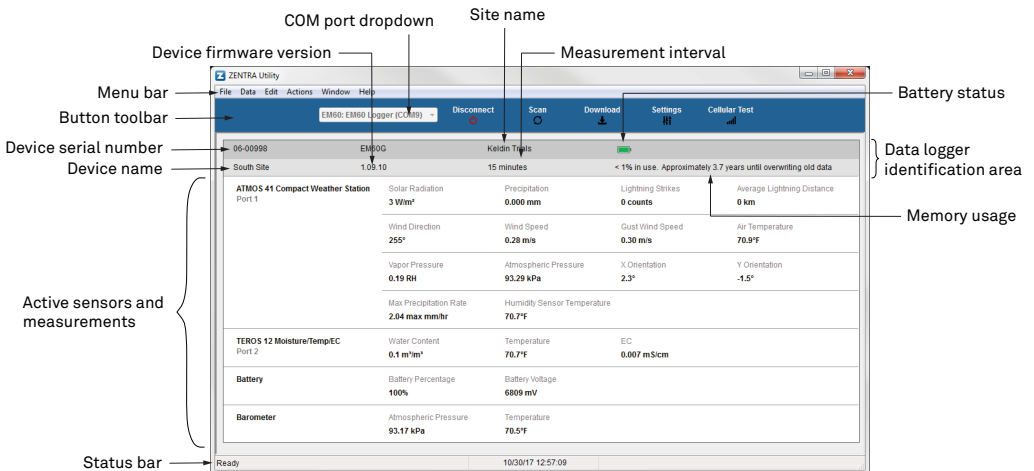

Figure 11 ZENTRA Utility Main Screen

4.1.1 BUTTON TOOLBAR

The Button toolbar provides shortcuts for the most frequent actions in using and configuring EM60 (Figure 11):

- **COM port dropdown menu:** Lists USB devices connected to the computer.
- **Connect/Disconnect:** Click the Connect button to attempt to connect to the device currently selected in the COM port dropdown menu. Click the Disconnect button to disconnect from the currently connected logger.
- **Scan:** Queries the connected EM60 for the current sensor readings and updates the active sensors and measurements area.
- **Download:** Downloads all data that has been collected on the EM60 since the last time a download from the selected logger.
- **Settings:** Opens the Manage Settings dialog (Section 4.1.6).
- **Cellular Test:** Opens the Cellular Communication Test dialog (Section 2.3).

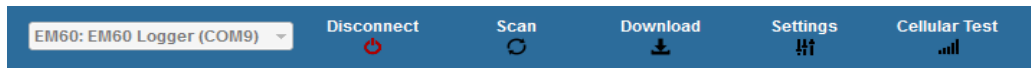

Figure 12 Button toolbar

4.1.2 DATA LOGGER IDENTIFICATION AREA

The Data Logger Identification area shows information for the connected EM60. Hover over each item for its label. Any customizable fields can be adjusted through the Manage Settings dialog (Section 4.1.6).

- **Serial Number:** The factory-set unique serial number for each EM60.
- **Device Type:** Model, either EM60 (logger without cellular) or EM60G (logger with cellular).
- **Site Name:** Customizable field to describe the EM60's location.
- **Remaining Battery Life:** Icon that shows the battery charge remaining on the device.
- **Cellular Strength:** Icon that shows the strength of the cellular signal. This appears only after the cellular communication test is completed (Section 2.3).
- **Device Name:** Customizable field to describe the EM60 device.
- **Firmware Version:** Version of firmware on the EM60.
- **Measurement Interval:** Customizable field that describes the frequency at which the EM60 will be recording measurements (Section 3.2.2).
- **Time until Overwriting Data:** Indicator of how much data is stored on the EM60 and how long it will be able to record more measurements before overwriting older data.

4.1.3 ACTIVE SENSORS AND MEASUREMENTS AREA

All sensors plugged into the EM60 are listed in this area and each sensor in this section is delimited by a horizontal bar. The left side of the section will have the sensor name and port number. The two on-board sensors (Battery and Barometer) will not show a port number. The right side of the section will list all measurements from the sensor, with a descriptor of the value. The measurements will use the units selected in the Manage Preferences Dialog ([Section 4.1.5](#)).

4.1.4 STATUS BAR

The Status bar in the bottom border of the screen will include what is happening in the software. It also shows the logger date and time.

4.1.5 MENU BAR

ZENTRA Utility Menu bar has six menus to access the program features: File, Data, Edit, Actions, Window, and Help.

FILE MENU

The File menu includes four options:

- **Disconnect:** Disconnect from a logger and end communications.
- **Stitch Together Excel Files:** Appends EM60 data by date from multiple Excel files into a single Excel file.
- **Separate Excel Files:** Separates a single EM60 Excel file into multiple Excel files by configuration type and then by every 65,000 measurements.
- **Exit:** Closes ZENTRA Utility.

DATA MENU

The Data menu has three options:

- **Download Data Since Last Download:** Download the data stored since the last successful download.
- **Download All:** Download all the data currently stored in the EM60.
- **Erase:** Deletes all stored data.

[Section 2.5](#) provides instructions for downloading data from the EM60 logger.

Most sensors compatible with the ZENTRA system do not require per-sensor calibration. The data downloaded by ZENTRA Utility will be calibrated correctly for each sensor type. The exception are soil moisture sensors that may require custom calibration for the soil type where they are installed. ZENTRA Utility uses a default calibration for soil moisture sensors that is appropriate for most mineral soils. If it is necessary to use a different soil moisture sensor calibration, change the Measurement Units to Raw VWC in the Manage Preferences

tab. Raw WVC values will be downloaded in the Processed Data worksheet and are available as inputs to custom calibration equations. See each specific sensor manual for alternative calibrations that can be applied to the raw data.

EDIT MENU

The Edit Menu allows the user to edit preferences in the Manage Preferences dialog. These preference configurations will only be saved to the computer, not as measuring preferences in the EM60 memory. It has four tabs for navigation:

- Measurements tab (Figure 13):
 - ♦ **Measurement Units:** Set preferences for measurement units by using the dropdown menus. Click OK to apply the changes.

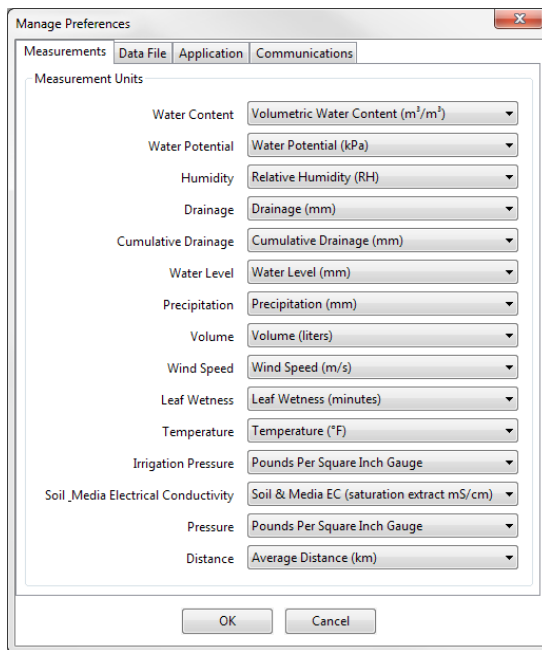

Figure 13 Measurements tab

- Data File tab (Figure 14):

- ♦ **Date and Time Display in ZENTRA Utility:** Change the format of date and time values by selecting an option from the dropdown menus. This controls how date and time are shown in ZENTRA Utility display and in the downloaded files.

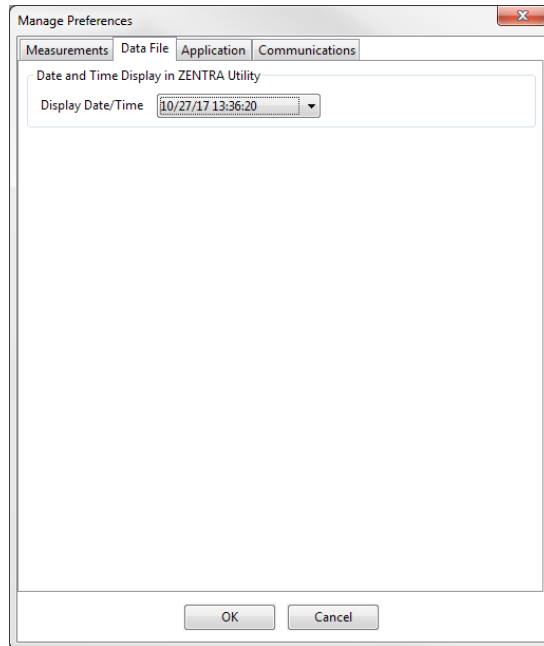

Figure 14 Data File tab

- Application tab (Figure 15):

- ♦ **Automatic Internet Version Check:** Select the checkbox next to automatically be notified when a newer ZENTRA Utility version becomes available. Updates can be searched for manually at any time in the Help menu.
- ♦ **Automatic Clock Synchronization:** Select the checkbox to keep the device clock synchronized with the connected computer's clock. The date and time can also be updated by using the Actions menu.

If the computer will not always have the correct time zone setting for the logger sites, deselecting this option will not override the setting in the logger.

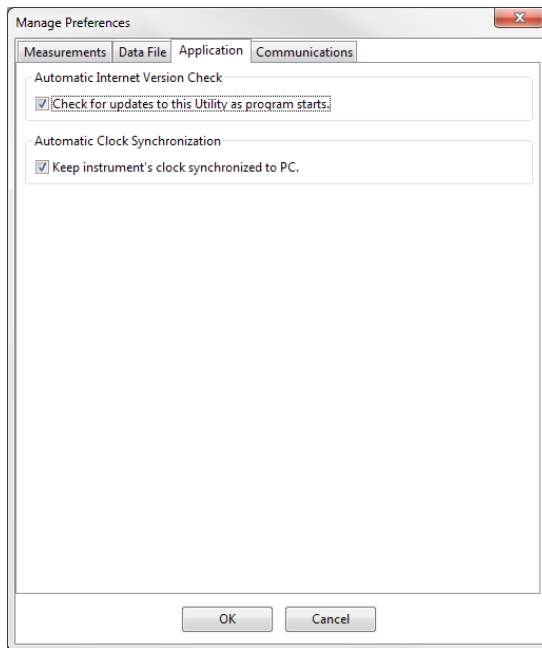

Figure 15 Application tab

• Communications tab (Figure 16):

- ♦ **Device Commands Retries:** Modifies the number of times ZENTRA Utility sends commands to a logger.
- ♦ **Communication Ports List:** Enable this option if the USB device does not appear in the Connect dropdown list.

NOTE: Enabling this option may also find COM ports that are unavailable for use by ZENTRA Utility.

- ♦ **Power Noise Filter:** Set the Power Frequency to eliminate electrical noise that comes from an AC power distribution system.

In North America and most of Asia, the frequency of the power cycle is 60 Hz (the default value); in most of Europe it is 50 Hz. This feature only needs to be set once, and the program will automatically update each connected device filter.

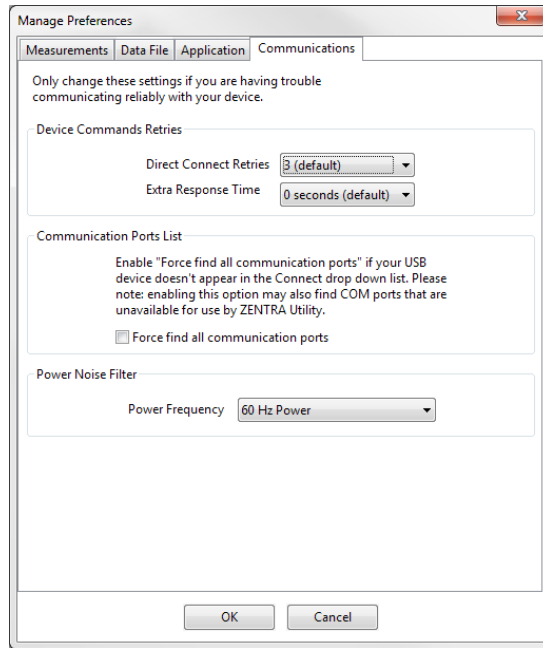

Figure 16 Communications tab

ACTIONS MENU

The Actions menu is the primary menu for configuring and testing the EM60 series logger.

- **Select Sensors:** Displays the Sensor Configuration tab in the Manage Settings dialog ([Section 4.1.6](#)).
- **Set Device Time:** Instructs ZENTRA Utility to set the EM60 time and date according to the time and date on the computer.
- **Digital Sensor Terminal:** Sends commands through the EM60 logger to a compatible METER digital sensor.
This feature can be used to troubleshoot the sensor by sending SDI-12 digital sensor communication commands. See respective sensor documentation for additional information on SDI-12 commands.
- **Cellular Test:** Evaluates the EM60G logger wireless signal ([Section 2.3](#)).
- **Cellular Configure:** Displays the Communication Settings tab in the Manage Settings dialog ([Section 4.1.6](#)).
- **List Cellular Carriers:** Queries the cellular module in the EM60G logger for a list of carriers it detects. This is useful when trying to troubleshoot cellular connection problems.

NOTE: EM60G may not be authorized to operate on any or all the carriers listed.

- **Device Information:** Displays the Device Information tab in the Manage Settings dialog (Section 4.1.6).
- **Device Location:** Displays the GPS Location tab in the Manage Settings dialog (Section 4.1.6). These are read-only fields because the logger has an on-board GPS module.
- **Show Raw Data/Show Processed Data:** Toggle showing raw or processed data in the instantaneous measurements area of the main screen. Use the raw data display to help troubleshoot poor sensor measurements.

WINDOW MENU

The Window menu provides the Show Terminal option. This allows for direct entry of commands to the EM60 and is mainly used for troubleshooting.

HELP MENU

The Help menu has five options.

- **Check for Software Updates:** Checks for the newest available version of the ZENTRA Utility. If a newer version is available, a prompt will appear to install the update. The computer must be connected to the internet for this feature to work. ZENTRA Utility checks for newer versions of the program each time it launches. It will download these updates in the background automatically.
- **Check for Logger Firmware Updates:** Checks for the newest version of EM60 firmware from METER. If a newer version is available, ZENTRA Utility downloads the new firmware in the background. When ZENTRA Utility connects to an EM60, it compares the firmware on the logger with the latest version available. If the EM60 firmware is out of date, ZENTRA Utility will prompt to start a firmware update for the logger. ZENTRA Utility maintains a cache of logger firmware to allow field firmware updates without a connection to the internet.
- **Update Sensor Firmware:** Some METER sensors (e.g., ATMOS and TEROS sensors) allow for firmware updates via ZENTRA Utility. Please consult the sensor user manual for more details.
- **Send Feedback to METER:** Sends product feedback, bug reports, or feature requests to METER when connected to the internet (Figure 17).

Figure 17 Send Feedback to METER Group window

Enter name, company name, and contact information in the form.

Identify the type of feedback being sent (general feedback, feature suggestions, bug report, or other).

Indicate how METER should respond (email or telephone).

Give details in the description area. If reporting a bug, detail what steps occurred prior to the bug and any error message. By default, bug reports include software error files. Other files can also be sent using this form (e.g., logger download files).

- **About ZENTRA Utility:** View the version of ZENTRA Utility currently installed.

4.1.6 MANAGE SETTINGS DIALOG

Changing the EM60 configuration happens in the Manage Settings dialog, which has four tabs. To access the Mange Settings dialog:

Click **Settings** on the **Button** toolbar ([Section 4.1.1](#)).

6. Make edits to the settings on the tabs. Refer to the details about the types of control settings in the following sections.
7. Click OK to save settings.
Click Cancel to exit without applying settings.

DEVICE INFORMATION TAB

Use the Device Information tab to edit the information that appears in the Data Logger Identification area ([Figure 18](#)).

- **Device Name:** Logger-specific name to identify the logger in the software. The default name is the unit serial number. It can be changed to a name representing the field or plot where the logger is installed or the types of sensors installed.
- **Site Name:** Area-specific name to identify where a group of loggers are located in the software. The Site Name is optional.
- **Serial Number:** Factory-set logger serial number that cannot be changed.
- **Time Zone:** Time zone automatically set from ZENTRA Utility software or the cellular system (EM60G).
- **Firmware Version:** Version of firmware on the EM60. Check for the latest version of logger firmware, using the Help menu ([Section 4.1.5](#)).
- **Device Type:** Model of the ZENTRA logger connected to ZENTRA Utility (not editable).

The image shows a screenshot of the 'Manage Settings' dialog box in ZENTRA Utility software. The 'Device Information' tab is selected, showing the following fields and values:

Field	Value
Device Name	South field
Site Name	Keldin Trials
Serial Number	06-00998
Time Zone	UTC-7
Firmware Version	1.09.10
Device Type	EM60G

At the bottom of the dialog, there are 'OK' and 'Cancel' buttons. The status bar at the very bottom of the window displays 'Ready'.

Figure 18 Manage Settings Device Information tab

SENSOR CONFIGURATION TAB

Use the Sensor Configuration tab to set the sensor measurement interval and to select sensors for each port ([Figure 19](#)).

- **Measurement Interval:** Controls how often the EM60 stores sensor data ([Section 3.2.2](#)).

NOTE: Setting the EM60 measurement interval to Off (not logging) turns off sensor measurement, data storage, and data uploads (EM60G).

- **Data Storage:** Shows the percentage of logger storage currently used and an approximation of when the logger will begin overwriting the oldest data. This calculation is based on the data already stored, measurement interval, and existing sensor types configured in each port of the logger.
- **Sensor port tabs:** Displays sensor type and firmware version (when applicable) for each sensor port on the logger. Select the correct sensor type from the dropdown menu to ensure correct sensor measurements.

NOTE: Only digital sensors have firmware versions.

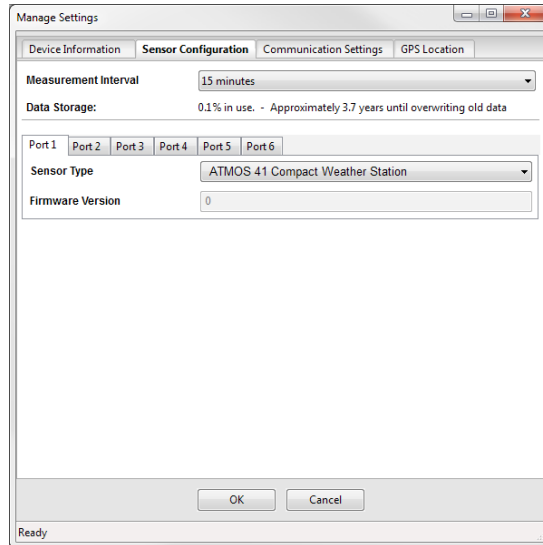

Figure 19 Manage Settings Sensor Configuration tab

COMMUNICATION SETTINGS TAB (EM60G)

Use the Communication Settings tab to control upload frequency and times for the EM60G (Figure 20).

- **Upload Frequency for each selected hour:** Enable or disable automatic data uploads from the EM60G to ZENTRA Cloud. The Upload Frequency describes how often data are uploaded each hour and is a different setting than the sensor measurement interval. Data are sent once per hour. If more frequent uploads are needed, please contact [Customer Support](#). METER offers cellular service plans that support uploading data every 15 min.
- **Upload Times:** Choose the approximate times of day that data are uploaded from the logger to ZENTRA Cloud. The data will be uploaded at a random time during each selected hour to upload data. To account for this variation, choose times prior to when the data is needed. By default, the EM60 is configured to upload data each hour. To conserve battery power, choose fewer upload times.

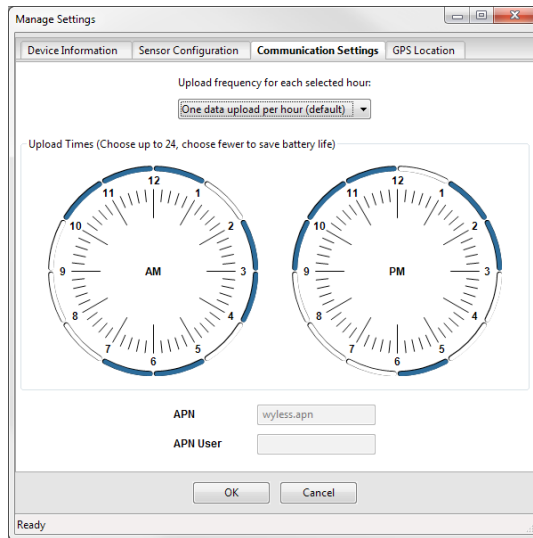

Figure 20 Manage Settings Communication Settings tab

GPS LOCATION TAB

All information in this tab are automatically provided by the GPS receiver in the EM60 and are read only (Figure 21).

- **Latitude/Longitude:** Provides GPS location of the EM60.
- **Altitude:** Contains altitude from sea level of the EM60.
- **Time Zone:** Offset from UTC time zone of the EM60.

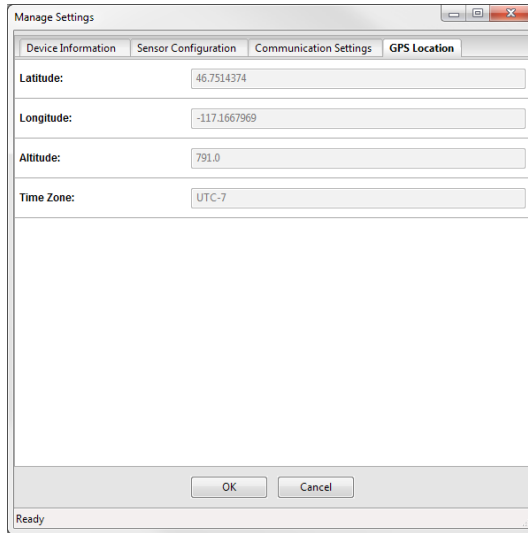

Figure 21 Manage Settings GPS Location tab

4.2 ZENTRA CLOUD (EM60G ONLY)

ZENTRA Cloud is a cloud-based web application to download, view, and share EM60G data as well as change logger configurations. ZENTRA Cloud is also designed to make it easy to share data with colleagues. This manual offers only an introduction to ZENTRA Cloud. Use the online help files to learn more about all the features of ZENTRA Cloud.

The first step to using the EM60G with ZENTRA Cloud is to create a customer site (a group of users and loggers).

1. Navigate to zentracloud.com.
2. Click the Sign Up button on the left side of the screen.
3. Enter the required information, including a valid email address.
4. Accept the terms and conditions.
5. Click Sign Up.
ZENTRA Cloud will send an email confirmation.
6. Click the link in the confirmation email inside email application.
7. Log in to ZENTRA Cloud.

To view data from EM60G loggers, subscribe to each desired EM60G logger on ZENTRA Cloud following the steps below. A logger can only belong to one site at a time.

NOTE: Depending on the organization, labels may be Farm and Field or Site and Plot.

1. Select New Farm on the lower left corner of the ZENTRA Cloud home screen.
2. Give the Farm a name.
A Farm can contain one or more Fields.
3. Select New Field from the button on the lower left corner.
4. Associate this Field to the Farm.
5. Give the Field a name.
A Field can contain one or more loggers.
6. Select New Subscription from the button the lower left corner.
7. Choose the Farm and Field.
8. Fill in the EM60G Device Serial Number and Device Password as shown on the device subscription card (Figure 22).

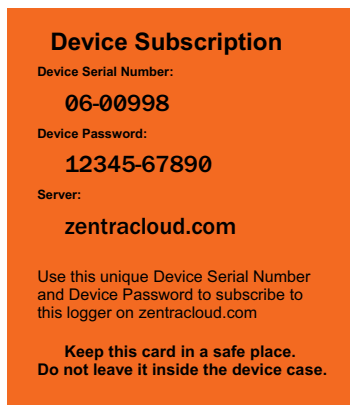

Figure 22 Device subscription card

Once subscribed to an EM60G, the logger should appear on the map and sensor data can be viewed and downloaded. Logger settings can be changed using ZENTRA Cloud. ZENTRA Cloud also provides a convenient way to share data from EM60G loggers with colleagues, with user-set permissions. See the online help files for more information.

5. SERVICE

This section describes the maintenance of the EM60. Troubleshooting solutions and customer service information are also provided.

5.1 MAINTENANCE

EM60 may be returned to METER for maintenance (inspect system, replace old or damaged parts, or update firmware). Select replacement parts (e.g., USB cable, antenna, case enclosure, gaskets) can also be ordered from METER. Contact [Customer Support](#) for more information. ZENTRA Utility makes it easy to send feedback, bug reports, and feature requests to METER ([Section 4.1.5](#)).

The EM60 requires little maintenance when installed correctly. Be sure to check EM60 logger periodically:

- Replace batteries as needed.
- Inspect the battery holders to ensure they are clean and free of corrosion.
- Verify that the sensor ports are clean and that the sensors are making good contact with the ports.

Clean the inside of the sensor ports with isopropyl alcohol and a swab if soil or other foreign materials are visible.

- Check case gaskets and sensor cable strain relief. Replace gaskets every 1 to 2 years as needed.
- Replace zip ties securing the logger annually or as needed.

NOTE: Never immerse the EM60 in liquids or bury the EM60. This and other misuse, improper protection, or improper installation may damage the EM60 and void the manufacturer's warranty.

NiMH batteries should last for several years if they are charging properly. Over a long period of time, NiMH batteries will begin to lose their charge capacity. If dark periods lasting months cause the batteries to discharge too low, it is time to replace the NiMH batteries. When replacing NiMH batteries, use high-quality batteries advertising higher charge capacity. New NiMH batteries may also be purchased from METER. Contact [Customer Support](#) to discuss concerns or recommendations.

Alkaline batteries should be replaced when the battery charge nears 0%. Replace batteries with high-quality alkaline batteries. A low-quality battery may not provide the desired battery life for the EM60 logger.

NOTE: Do not mix NiMH and alkaline batteries together. Do not mix new and old alkaline batteries together.

NOTE: Installing or replacing the batteries in the EM60 resets the internal real-time clock. The EM60 time can be set from ZENTRA Utility, the on-board GPS receiver, and the cellular network (EM60G). Press the TEST button after changing the batteries to enable the GPS receiver to acquire a new time and position fix.

5.2 TROUBLESHOOTING

Although METER designed the EM60 for durability and built to the highest manufacturing standards, problems may occasionally occur. This troubleshooting section details the major problems and their solutions. If the problem is not listed or these solutions do not solve the issue, contact [Customer Support](#).

Table 2 Troubleshooting EM60

Problem	Possible Solutions
<p>ZENTRA Utility cannot connect to the device or EM60 logger not showing in the COM port picker</p>	<p>If using a Windows computer, reinstall the USB driver from metergroup.com/em60-support.</p> <p>Mac computers running ZENTRA Utility do not require a custom USB driver. NOTE: The Em50 driver and USB Cable Adapter will not work for the EM60.</p> <p>Check that the USB cable is securely plugged into the logger and the computer.</p> <p>Ensure the logger has good batteries.</p> <p>Press the TEST button on the logger to reset it.</p> <p>Connect to a second logger. If the connection works, the problem is likely with the first logger.</p> <p>Try a different micro-USB cable. Ensure the cable is not intended for charging only.</p>
<p>ZENTRA Utility reports it lost the connection</p>	<p>Check or replace the USB cable.</p> <p>Increase the number of times ZENTRA Utility tries sending commands to the logger:</p> <ul style="list-style-type: none"> • Go to the Manage Preferences menu. • Select the Communication tab. • Increase the Direct Connect Retries.
<p>ZENTRA Utility states there is no new data for downloading or Logger stopped making measurements</p>	<p>Wait for at least the length of the measurement interval to ensure the logger had enough time to record data.</p> <p>Ensure the logger is configured to measure data, i.e., make sure the measurement interval is not set to Off (not logging).</p> <p>Check the battery. The EM60 will stop making sensor measurements when the batteries are extremely low.</p> <p>Press the TEST button to reset the logger.</p>

Table 2 Troubleshooting EM60 (continued)

Problem	Possible Solutions
<p>Sensor data shows No response from sensor in the Scan window or Downloaded data shows #N/A</p>	<p>The raw data measured by the logger is out of expected range for the sensor. This could be caused by an unplugged or broken sensor.</p> <p>Ensure the sensor is fully inserted into the logger sensor port.</p> <p>Ensure the sensor type shown in the Scan window matches the sensor connected to the logger.</p> <p>Switch the sensor to a known working port and scan again. If the sensor shows data, the port may be damaged. If the No response from sensor is still presenting, the sensor could be unplugged or broken.</p> <p>If the problem persists, contact Customer Support.</p>
<p>Sensor measurement data does not seem to be correct</p>	<p>Switch the sensor to a known working port and scan again. If the problem follows the sensor, then the sensor may be damaged.</p> <p>Many issues affect the quality of the sensor measurement. Please see the sensor user manual for troubleshooting.</p>
<p>Red ERROR light and/or green OK light are always on</p>	<p>Check logger batteries.</p> <p>Press the TEST button to reset the EM60.</p> <p>If the problem persists, contact Customer Support.</p>
<p>Red ERROR light is on after pressing the TEST button</p>	<p>See Section 3.2.3 for information on the TEST button results and how to further troubleshoot.</p>
<p>Cellular uploads stopped working (EM60G)</p>	<p>Check antenna.</p> <p>Press the TEST button to reset the EM60.</p> <p>Run the Cellular Communication Test in ZENTRA Utility to determine if there is a communication error.</p> <p>Check the List Cellular Carriers in ZENTRA Utility to confirm there are cellular carriers operating in the area.</p> <p>If the problem persists, contact Customer Support.</p>
<p>Logger does not seem to be working correctly or reliably</p>	<p>Press the TEST button on the logger to reset the EM60.</p> <p>Check logger batteries. Replace alkaline batteries if close to 0%. Recharge NiMH batteries if close to 0%.</p> <p>Check for corrosion or water damage. Check that the seals and gaskets are intact.</p> <p>If the problem persists, contact Customer Support.</p>

5.3 CUSTOMER SUPPORT

Customer service representatives are available for questions, problems, or feedback Monday through Friday, 8 am–5 pm Pacific time.

Email: support.environment@metergroup.com
sales.environment@metergroup.com

Phone: +1.509.332.5600

Fax: +1.509.332.5158

Website: metergroup.com

If contacting METER by email or fax, please include the following information:

Name	Email address
Address	Instrument serial number
Phone	Description of the problem

NOTE: For EM60 data loggers purchased through a distributor, please contact the distributor directly for assistance.

5.4 TERMS AND CONDITIONS

By using METER instruments and documentation, you agree to abide by the METER Group, Inc. USA Terms and Conditions. Please refer to metergroup.com/terms-conditions for details. For terms and conditions specific to EM60G data storage, refer to metergroup.com/zentra-cloud-terms-conditions.

APPENDIX A. COMPLIANCE CERTIFICATIONS

This appendix contains compliance statements that apply to the EM60 and EM60G.

A.1 USA

The following FCC statement applies to the EM60 and EM60G. This device complies with Part 15 of the FCC Rules. Operation is subject to the following conditions:

1. This device may not cause harmful interference.
2. This device must accept any interference received, including interference that may cause undesired operation.

The EM60 series loggers contain one or more of the following radio modules, listed by their FCC identification numbers:

- SH6MDBT40 (all EM60 series)
- XPYLISAU201 or XPYLISAU200 (EM60G only)

Changes or modifications to the EM60 series loggers not expressly approved by METER Group, Inc. USA could void FCC compliance and thus the user's authority to operate the equipment.

This equipment has been tested and found to comply with the limits for a Class B digital device, pursuant to Part 15 of the FCC Rules. These limits are designed to provide reasonable protection against harmful interference in a residential installation. This equipment generates, uses, and can radiate radio frequency energy and, if not installed and used in accordance with the instructions, may cause harmful interference to radio communications.

There is no guarantee that a particular installation will not cause any interference. If this equipment does cause harmful interference to radio or television reception, which can be determined by turning the equipment off and on, METER encourage users to attempt to correct the interference by trying one or more of the following measures:

- Reorient or relocate the receiving antenna
- Increase the separation between the equipment and receiver
- Consult [Customer Support](#)

A.2 CANADA

Industry Canada (IC) Notices

This Class B digital apparatus complies with Canadian CAN ICES-3(B) / NMB-3(B) and RSS-210.

Operation is subject to the following two conditions:

- this device may not cause interference
- this device must accept any interference, including interference that may cause undesired operation of the device

The EM60 series loggers contain one or more of the following radio modules, listed by their IC identification numbers:

8017A-MDBT40 (all EM60 series)

8595A-LISAU201 or 8595A-LISAU200N (EM60G only)

Radio Frequency (RF) Exposure Information

This device has been evaluated and shown compliant with the IC RF Exposure limits under mobile exposure conditions (antennas are greater than 20cm from a person's body).

Avis d'Industrie Canada (IC)

Cet appareil numérique de classe B est conforme aux normes canadiennes CAN ICES-3(B) / NMB- 3(B) et RSS-210.

Son fonctionnement est soumis aux deux conditions suivantes:

- cet appareil ne doit pas causer d'interférence
- cet appareil doit accepter toute interférence, notamment les interférences qui peuvent affecter son fonctionnement

Informations concernant l'exposition aux fréquences radio (RF)

Ce périphérique a été évalué et démontré conforme aux limites d'exposition aux fréquences radio (RF) d'IC lorsqu'il est installé dans des produits hôtes particuliers qui fonctionnent dans des conditions d'exposition à des appareils mobiles (les antennes se situent à plus de 20 centimètres du corps d'une personne).

Changes or modifications to the EM60 series loggers not expressly approved by METER Group, Inc. USA could void Industry Canada (IC) compliance and thus the user's authority to operate the equipment.

A.3 EUROPEAN UNION

R&TTED and European Conformance CE mark

Radiofrequency radiation exposure Information: this equipment complies with radiation exposure limits prescribed for an uncontrolled environment for fixed and mobile use conditions. This equipment should be installed and operated with a minimum distance of 20 cm between the radiator and the body of the user or nearby persons. This transmitter must not be co-located or operating in conjunction with any other antenna or transmitter except as authorized in the certification of the product.

A full CE declaration of conformity for the EM60 is available on request from METER Group.

A.4 JAPAN

TELEC (Japan)



The EM60 series loggers contain one or more of the following radio modules that are TELEC/JATE certified.

All EM60 series:

- Technical Requirements certified type number = 204-420020

EM60G with TELEC-approved cellular module:

- Technical Conditions certified type number = AD120274003
- Technical Requirements certified type number = 003-120375

INDEX

B

battery

- alkaline 2, 3, 12, 16, 33
- charging 12, 16–17
- diagram 14
- life 12, 16–17
- NiMH 1, 3, 12, 14, 16, 33
- replacing 33
- types 16–17

C

- cellular communications test 9–10
- cellular module 13, 18
- communications settings 29
- compliance
 - CE 13, 38
 - FCC 37
 - IC 38–39
 - ISO 9001:2015 13
 - TELEC 39
- components 13–18
 - antenna 2
 - battery 16–17
 - connections 14
 - enclosure 12–13, 14
 - GPS 12, 17
 - included 1
 - memory 12
- configuration 4–9
 - computer communication 12
 - using ZENTRA Utility 27–31
- contact information
 - customer support 36
 - ZENTRA Utility support 26–27

D

- data collection 18
 - data storage 29
 - metadata 11
 - timekeeping 17
- data deletion 11

data download

- using ZENTRA Cloud 11, 32
- using ZENTRA Utility 10–11, 20

F

- firmware 16, 20, 26, 28

G

- GPS 30. See also specifications, GPS

I

- installation 2–3
 - sensors 4
 - software 2
 - solar panel optimization 16
 - tools needed 2
- instantaneous scan 4, 10

M

- maintenance 33
- measurement interval 8, 15, 28
- models 13

S

- scan 4, 10, 19, 20, 35
- sensor measurements 10, 14–15
- specifications 12–13
 - cellular 12
 - enclosure 12–13
 - GPS 12
- status lights 2, 16
- support 36

T

- terms and conditions 36
- TEST button 14, 15–16
- troubleshooting 34–35
 - cellular communications test 9–10
 - TEST button 15

W

- wireless data transmission
 - cellular communications test 9–10
 - cellular module 13, 18
 - communication settings 29–30
 - supported networks 18

Z

ZENTRA Cloud 31–32

ZENTRA Utility

- Actions menu 25–26
- configuration 4–9
- Data menu 21–22
- Edit menu 22–25
- File menu 21
- Help menu 26–27
- main screen 19
- operating systems 19
- settings 27–30
- Window menu 26

METER Group, Inc. USA
2365 NE Hopkins Court
Pullman, WA 99163
T: +1.509.332.2756 F: +1.509.332.5158
E: info@metergroup.com
W: www.metergroup.com

